

Collezione **NEW ROSSANA** struttura **BROOKLYN**

Gamba a ponte

FINITURE

Alluminio RAL 9006

Finitura piani: Betulla, bianco,
grigio, pero, wengé

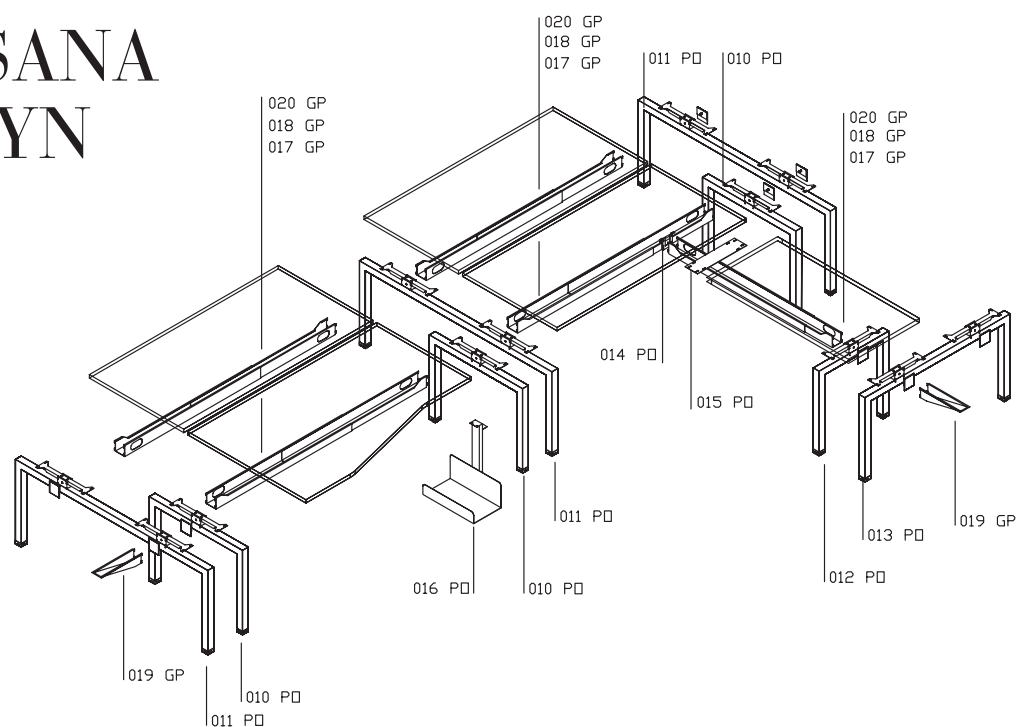

Scheda Tecnica

Gamba a ponte mod. Brooklyn Elementi strutturali

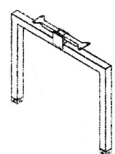

Gamba singola scrivania
art. 010 PO - L 800 P 50 H 690

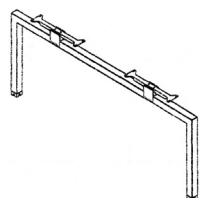

Gamba doppia scrivania
art. 011 PO - L 1640 P 50 H 690

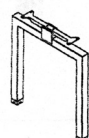

Gamba singola dattilo
art. 012 PO - L 600 P 50 H 690

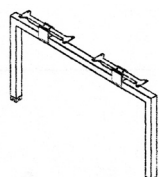

Gamba doppia dattilo
art. 013 PO - L 1240 P 50 H 690

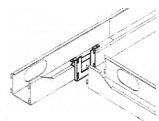

Connettore 90° Trave
art. 014 PO



Travi telescopica elettrificabile
art. 020 GP - L 1400/2400 P 70 H 80
art. 017 GP - L 1200/2000 P 70 H 80
art. 018 GP - L 800/1200 P 70 H 80

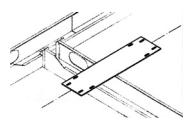

Piastra giunzione piani dattilo
art. 015 PO - L 416 P 104 sp.3

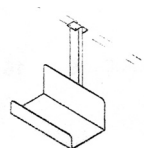

Porta CPU sospeso
art. 016 PO - L 235 P 430 H 510



Terminale supporto penisole
art. 019 PO - L 400

Scrivanie gamba a ponte Brooklyn

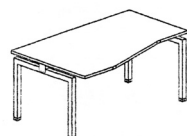

Scrivanie asimmetrica
art. NR 302 PO dx/sx - L 160 P 100/80 H 72
art. NR 301 PO dx/sx - L 140 P 100/80 H 72



Scrivanie lineare **P 100**
art. NR 405 PO - L 200 P 100 H 72

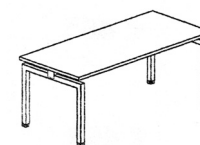

Scrivanie lineare **P 80**
art. NR 106 PO - L 180 P 80 H 72
art. NR 105 PO - L 160 P 80 H 72
art. NR 104 PO - L 140 P 80 H 72
art. NR 103 PO - L 120 P 80 H 72
art. NR 102 PO - L 100 P 80 H 72
art. NR 101 PO - L 80 P 80 H 72

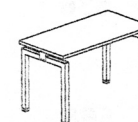

Scrivanie lineare **P 60**
art. NR 203 PO - L 120 P 60 H 72
art. NR 202 PO - L 100 P 60 H 72
art. NR 201 PO - L 80 P 60 H 72

Allunghi

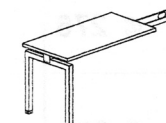

Allungo laterale lineare **P 60**
art. NR 243 PO - L 120 P 60 H 72
art. NR 242 PO - L 100 P 60 H 72
art. NR 241 PO - L 80 P 60 H 72

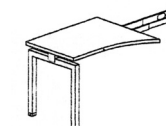

Allungo laterale sagomato
art. NR 244 PO dx/sx - L 90 P 80/60 H 72

Workstation

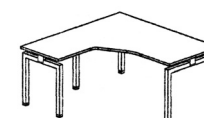

Workstation
art. NR 305 PO dx/sx - L 160/160 P 80/60 H 72
art. NR 304 PO dx/sx - L 160/120 P 80/60 H 72
art. NR 303 PO dx/sx - L 140/140 P 80/60 H 72

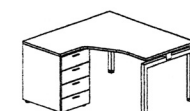

Workstation su cassetteria portante
art. NR 355 PO dx/sx - L 160/160 P 80/60 H 72
art. NR 353 PO dx/sx - L 140/140 P 80/60 H 72

Scrivanie e allunghi gamba a ponte Brooklyn



Scrivanie **L 180** con allungo complanare
art. NR 106 243 PO - L 180 P 200 (80+120) H 72
art. NR 106 242 PO - L 180 P 180 (80+100) H 72
art. NR 106 241 PO - L 180 P 160 (80+ 80) H 72

Scrivanie **L 160** con allungo complanare
art. NR 105 243 PO - L 160 P 200 (80+120) H 72
art. NR 105 242 PO - L 160 P 180 (80+100) H 72
art. NR 105 241 PO - L 160 P 160 (80+ 80) H 72

Scrivanie **L 140** con allungo complanare
art. NR 104 243 PO - L 140 P 200 (80+120) H 72
art. NR 104 242 PO - L 140 P 180 (80+100) H 72
art. NR 104 241 PO - L 140 P 160 (80+ 80) H 72

Scrivanie **L 120** con allungo complanare
art. NR 103 243 PO - L 120 P 200 (80+120) H 72
art. NR 103 242 PO - L 120 P 180 (80+100) H 72
art. NR 103 241 PO - L 120 P 160 (80+ 80) H 72

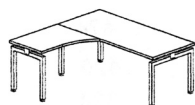

Scrivanie **L 180** con allungo sagomato
art. NR 106 244 PO dx/sx
 L 180 P 170 (80+90) H 72

Scrivanie **L 160** con allungo sagomato
art. NR 105 244 PO dx/sx
 L 160 P 170 (80+90) H 72

Scrivanie **L 140** con allungo sagomato
art. NR 104 244 PO dx/sx
 L 140 P 170 (80+90) H 72

Scrivanie **L 120** con allungo sagomato
art. NR 103 244 PO dx/sx
 L 120 P 170 (80+90) H 72

Postazioni multiple gamba a ponte Brooklyn

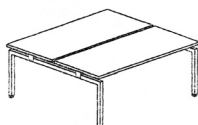

Postazione multipla
art. NR 116 PO - L 180 P 164 H 72
art. NR 115 PO - L 160 P 164 H 72
art. NR 114 PO - L 140 P 164 H 72
art. NR 113 PO - L 120 P 164 H 72
art. NR 112 PO - L 100 P 164 H 72
art. NR 111 PO - L 80 P 164 H 72

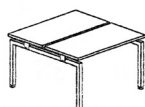

Postazione multipla
art. NR 213 PO - L 120 P 124 H 72
art. NR 212 PO - L 100 P 124 H 72
art. NR 211 PO - L 80 P 124 H 72

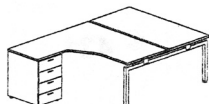

Postazione multipla con cassetteria portante
art. NR 365 PO dx/sx
 L 160 P 246 (80+160) H 72

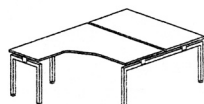

Postazione multipla
art. NR 325 PO dx/sx
 L 160 P 246 (80+160) H 72

art. NR 324 PO dx/sx
 L 160 P 206 (80+120) H 72

art. NR 323 PO dx/sx
 L 140 P 226 (80+140) H 72

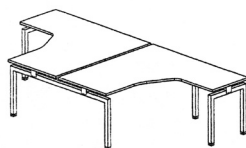

Postazione multipla
art. NR 315 PO
 L 160 P 326 (160+160) H 72

art. NR 314 PO
 L 160 P 246 (120+120) H 72

art. NR 313 PO
 L 140 P 286 (140+140) H 72

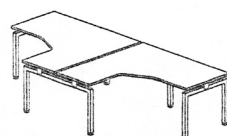

Postazione multipla
art. NR 335 PO
 L 326 (160+160) x P 160 H 72

art. NR 334 PO
 L 326 (160+160) x P 120 H 72

art. NR 333 PO
 L 286 (140+140) x P 120 H 72

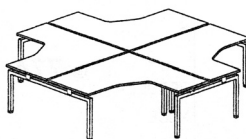

Postazione multipla
art. NR 345 PO
 L 326 (160+160) x P 326 (160+160)

art. NR 344 PO
 L 326 (160+160) x P 246 (120+120)

art. NR 343 PO
 L 286 (140+140) x P 286 (140+140)

Scrivanie aggregabili gamba a ponte Brooklyn

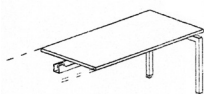

Scrivania **P 80** aggregabile in linea
art. NR 126 PO - L 180 P 80
art. NR 125 PO - L 160 P 80
art. NR 124 PO - L 140 P 80
art. NR 123 PO - L 120 P 80
art. NR 122 PO - L 100 P 80
art. NR 121 PO - L 80 P 80

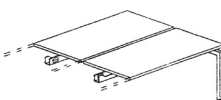

Scrivania **P 80 doppia** aggregabile in linea
art. NR 136 PO - L 180 P 166
art. NR 135 PO - L 160 P 166
art. NR 134 PO - L 140 P 166
art. NR 133 PO - L 120 P 166
art. NR 132 PO - L 100 P 166
art. NR 131 PO - L 80 P 166



Scrivania **P 60** aggregabile in linea
art. NR 223 PO - L 120 P 60
art. NR 222 PO - L 100 P 60
art. NR 221 PO - L 80 P 60

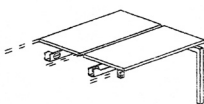

Scrivania **P 60 doppia** aggregabile in linea
art. NR 233 PO - L 120 P 126
art. NR 232 PO - L 100 P 126
art. NR 231 PO - L 80 P 126

Tavoli riunione gamba a ponte Brooklyn

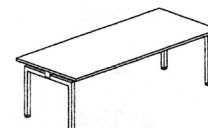

Tavolo riunione
art. NR 405 PO - L 200 P 100 H 72

New Rossana Brooklyn piani in vetro

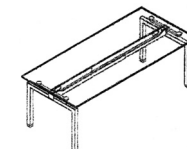

Scrivania
art. BV1 - L 200 P 90 H 72
art. BV2 - L 180 P 80 H 72
art. BV3 - L 160 P 80 H 72

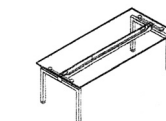

Allungo scrivania
art. BV4 - L 120 P 60 H 72

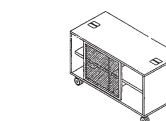

Mobile di servizio
art. BV20 - L 95 P 45 H 56

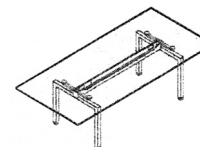

Tavolo riunione
art. BV10 - L 240 P 110 H 72



Tavolo tondo
art. BV30 - diam. 126

Kit 4 ruote per contenitori

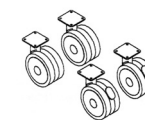

Kit 4 ruote per contenitori
 a giorno o ante legno:
 (2 libere/2 con freno)
art. 0700 - H. da terra 90 mm Ø 75 mm



Cassetteria in metallo

Cassettiere 3 cassetti
art. 0173M - L 45 P 60 H 50

Contenitori con ante scorrevoli New Rossana Brooklyn vetro

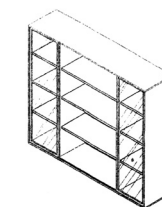

Mobile ante scorrevoli
 Ante telaio alluminio **vetro trasparente**
art. 0160-42 T - L 180 P 42,6 H 163

Ante telaio alluminio **vetro acidato**
art. 0160-42 A - L 180 P 42,6 H 163

Ante telaio alluminio **vetro retrolaccato bianco**
art. 0160-42 B - L 180 P 42,6 H 163

Ante telaio alluminio **vetro retrolaccato nero**
art. 0160-42 N - L 180 P 42,6 H 163

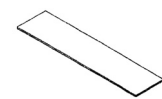

Top di finitura
art. 0160-42 - L 180 P 45 sp. 3